

**Itthon**

# VENTILACIÓN

**2025**

**INDUSTRIAL**

[www.itthoninnovation.com](http://www.itthoninnovation.com)



# Itthon

## Ventilación Industrial Suelo

# 01

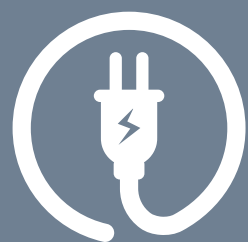

220V /50HZ



2300m<sup>3</sup>/h



35,5cm

Ajustable



Metálico



Ref: ITTVI-25014NF

### Ventilador industrial de suelo Negro

Ventilador de suelo industrial resistente con 3 velocidades. Ideal para fábricas, talleres y espacios amplios.

#### Especificaciones:

Voltaje 220V~260V

Frecuencia 50-60Hz

Potencia 60W

Diámetro :35,5cm/14"

Cable 1.7m

EAN:8436601648242

Regulaciones: Rohs, CE

[www.itthoninnovation.com](http://www.itthoninnovation.com)

CE Rohs



# Itthon

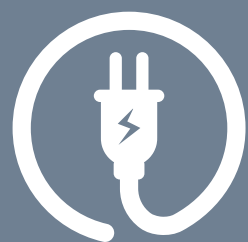

220V /50HZ



2300m<sup>3</sup>/h



35,5cm

Ajustable



Metálico



# Ventilación Industrial

## Suelo

# 01

Ref: ITTVI-25014CF

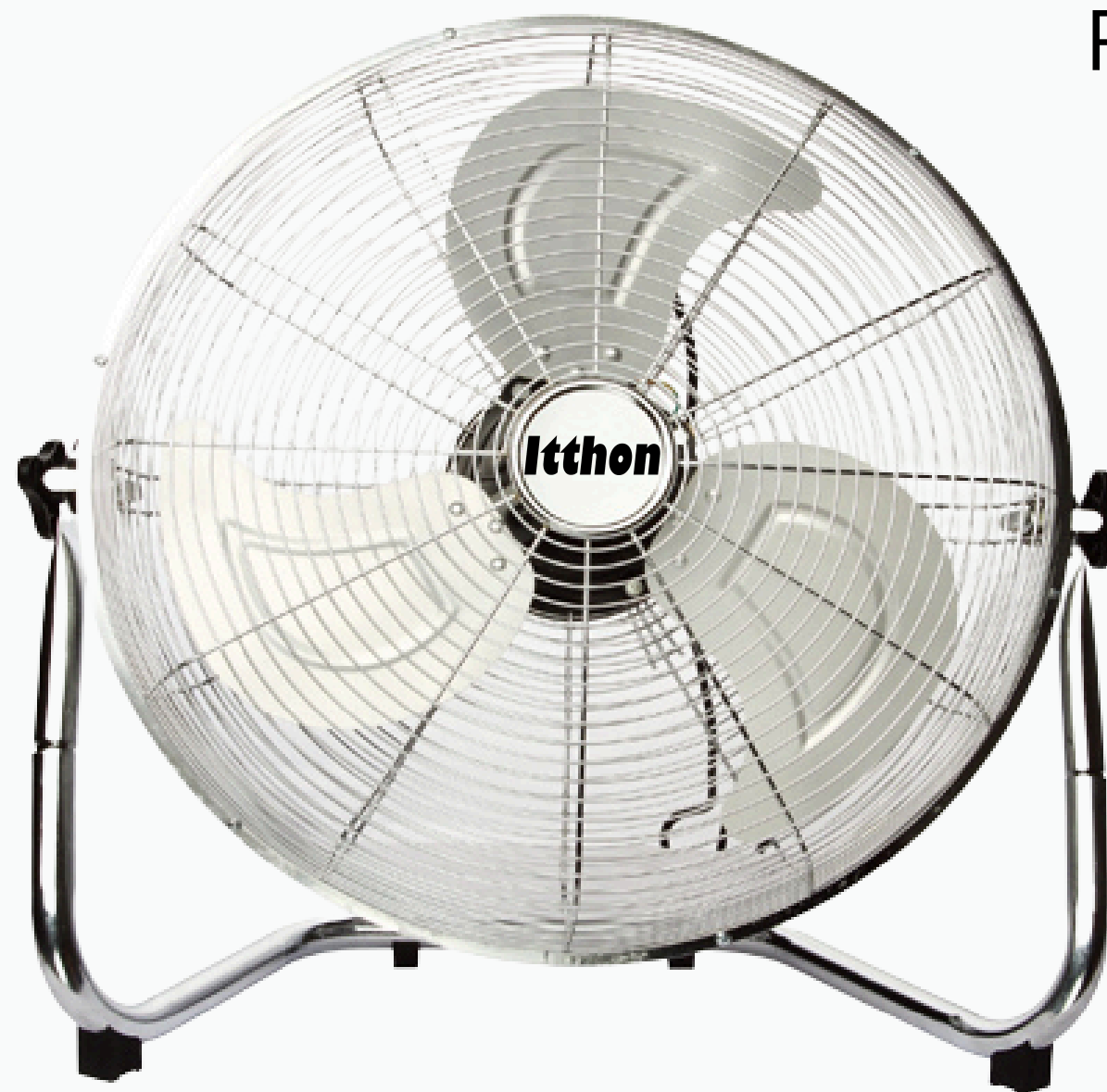

### Ventilador industrial de suelo Cromo

Ventilador de suelo industrial resistente con 3 velocidades. Ideal para fábricas, talleres y espacios amplios.

#### Especificaciones:

Voltaje 220V~260V

Frecuencia 50-60Hz

Potencia 60W

Diámetro :35,5cm/14"

Cable 1.7m

EAN:8436601648266

Regulaciones: Rohs, CE

[www.itthoninnovation.com](http://www.itthoninnovation.com)

CE Rohs



# Itthon

## Ventilación Industrial Suelo

# 01

Ref: ITTVI-25018NF

### Ventilador industrial de suelo negro

Ventilador de suelo industrial resistente con 3 velocidades. Ideal para fábricas, talleres y espacios amplios.

#### Especificaciones:

Voltaje 220V~260V  
Frecuencia 50-60Hz  
Potencia 100W  
Diámetro :45cm/18"  
Cable 1.7m

EAN: 8436601648259

Regulaciones: Rohs, CE

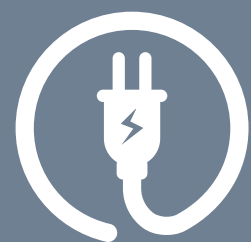

220V /50HZ



2800m<sup>3</sup>/h



45cm

Ajustable



Metálico



[www.itthoninnovation.com](http://www.itthoninnovation.com)

CE Rohs



# Itthon

## Ventilación Industrial Suelo

# 01

Ref: ITTVI-25020CF

### Ventilador industrial de suelo cromo

Ventilador de suelo industrial resistente con ángulo ajustable y varias velocidades. Ideal para fábricas, talleres y espacios amplios.

#### Especificaciones:

Voltaje 220V

Frecuencia 50Hz

Potencia 120W

Diámetro 50CM

Cable 1.7m



EAN: 8436601647412

Regulaciones: Rohs, CE

[www.itthoninnovation.com](http://www.itthoninnovation.com)

CE Rohs

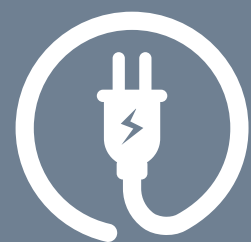

220V /50HZ



3100m<sup>3</sup>/h



50cm

Montaje

EASY



Metálico



# Itthon

## Ventilación Industrial Suelo

# 01

Ref: ITTVI-25014NN



### Ventilador industrial de suelo con pie

Ventilador de suelo industrial resistente con cabezal oscilante y 3 velocidades. Ideal para fábricas, talleres y espacios amplios.

#### Especificaciones:

Voltaje 220V

Frecuencia 50~60Hz

Potencia 60W

Tamaño 35cm/14"

Cable 1.7m

EAN: 8436601647634

Regulaciones: Rohs, CE

[www.itthoninnovation.com](http://www.itthoninnovation.com)

CE Rohs

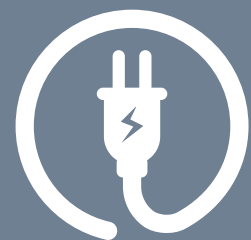

220V /50HZ



2500m<sup>3</sup>/h



35cm

Montaje

EASY



Metálico



# Itthon

## Ventilación Industrial Suelo

# 01

Ref: ITTVI-25014NP

### Ventilador industrial de suelo con pie

Ventilador de suelo industrial resistente con cabezal oscilante y 3 velocidades. Ideal para fábricas, talleres y espacios amplios.

#### Especificaciones:

Voltaje 220V

Frecuencia 50~60Hz

Potencia 60W

Tamaño 35cm/14"

Cable 1.7m



EAN: 8436601648327

Regulaciones: Rohs, CE

[www.itthoninnovation.com](http://www.itthoninnovation.com)

CE Rohs

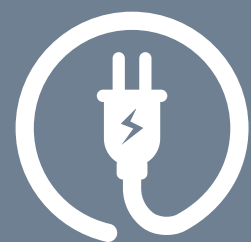

220V /50HZ



2500m<sup>3</sup>/h



35cm

Montaje

EASY



Metálico



# Itthon

# Ventilación Industrial Pared

# 01

Ref:ITTVI-25020NW

## Ventilador industrial de pared negro

Ventilador de pared industrial resistente con 3 velocidades.Oscilobatiente, programación de tiempo

### Especificaciones:

Voltaje 220V~260V  
Frecuencia 50-60Hz  
Potencia 120W  
Diámetro :50cm/20"  
Cable 1.7m

EAN:8436601648297

Regulaciones: Rohs, CE

www.itthoninnovation.com

CE ROHS

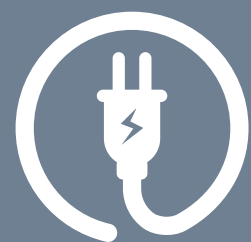

220V /50HZ



3800m<sup>3</sup>/h



50cm

Montaje

EASY

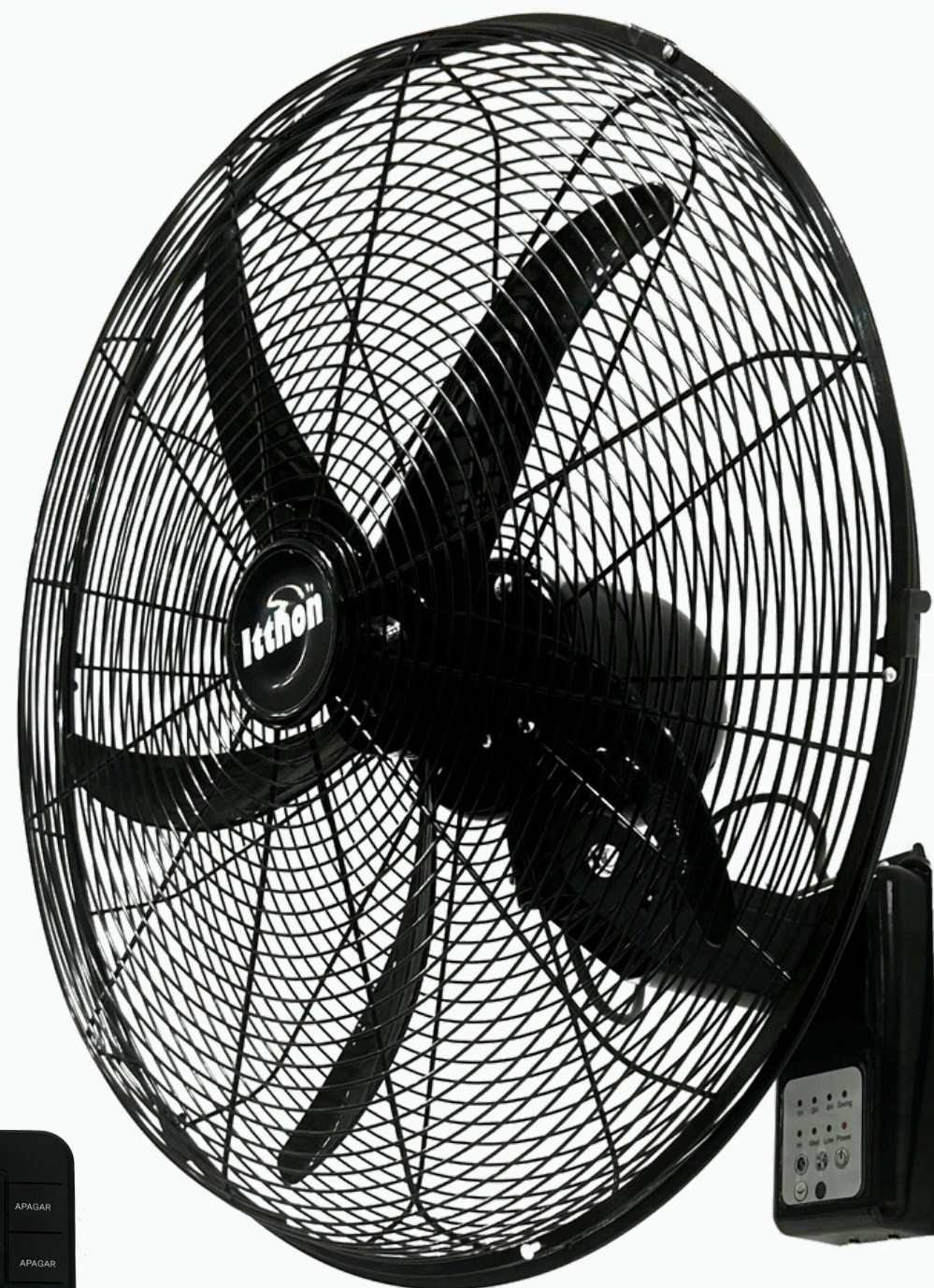



# Itthon

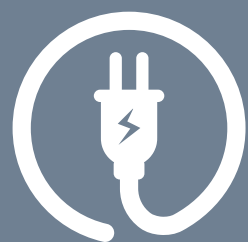

220V /50HZ



3800m<sup>3</sup>/h



50cm

Montaje

EASY



# Ventilación Industrial Pared 01

Ref: ITTVI-25020CW

## Ventilador industrial de pared plata

Ventilador de pared industrial resistente con 3 velocidades. Oscilobatiente, programación de tiempo

### Especificaciones:

Voltaje 220V~260V

Frecuencia 50-60Hz

Potencia 120W

Diámetro :50cm/20"

Cable 1.7m

EAN:8436601648303

Regulaciones: Rohs, CE

www.itthoninnovacion.com



# Itthon

## Ventilación Industrial Pared

# 01

Ref: ITTVI-25014NW



### Ventilador industrial de pared negro

Ventilador de pared industrial resistente con 3 velocidades. Ideal para fábricas, talleres y espacios amplios.

#### Especificaciones:

Voltaje 220V~260V  
Frecuencia 50-60Hz  
Potencia 40W  
Diámetro :35,5cm/14"  
Cable 1.7m

EAN:8436601648273

Regulaciones: Rohs, CE

[www.itthoninnovation.com](http://www.itthoninnovation.com)

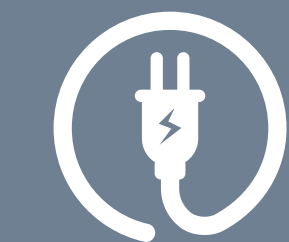

220V /50~60HZ



1500m<sup>3</sup>/h



35,5cm

Montaje



Metálico



CE Rohs



# Itthon

## Ventilación Industrial Pared

# 01

Ref: ITTVI-25014CW

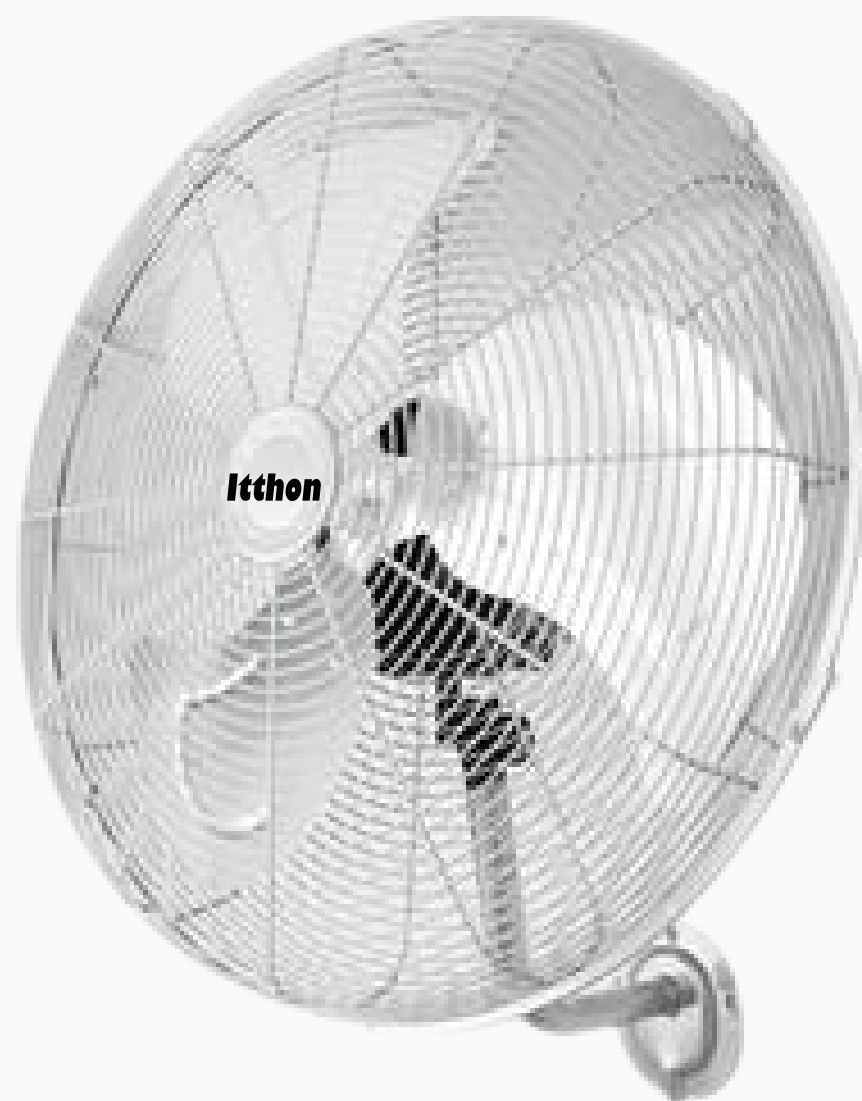

### Ventilador industrial de pared cromo

Ventilador de pared industrial resistente con 3 velocidades. Ideal para fábricas, talleres y espacios amplios.

#### Especificaciones:

Voltaje 220V~260V  
Frecuencia 50-60Hz  
Potencia 40W  
Diámetro :35,5cm/14"  
Cable 1.7m

EAN:8436601648280

Regulaciones: Rohs, CE

[www.itthoninnovation.com](http://www.itthoninnovation.com)

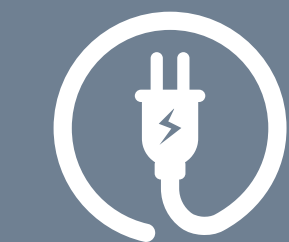

220V /50~60HZ



1500m<sup>3</sup>/h



35,5cm

Montaje



Metálico



CE Rohs



# Itthon

## Ventilación Industrial Pared

# 01

Ref: ITTVI-25030NW

### Ventilador industrial de pared negro

Ventilador de pared industrial resistente con 3 velocidades. Ideal para fábricas, talleres y espacios amplios.

#### Especificaciones:

Voltaje 220V~240V  
Frecuencia 50~60Hz  
Potencia 200W  
Diámetro 76cm  
Cable 1.7m

EAN: 8436601648310

Regulaciones: Rohs, CE

[www.itthoninnovation.com](http://www.itthoninnovation.com)

CE Rohs

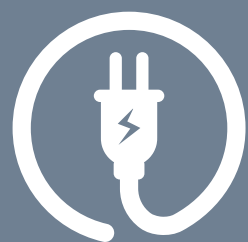

220V /50HZ



5000m<sup>3</sup>/h



76cm

Montaje

EASY



Metálico



# Itthon

## Ventilación Industrial Pared

# 01

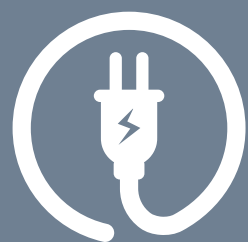

220V /50HZ



3800m<sup>3</sup>/h



50cm

Montaje

EASY



Metálico



Ref: ITTVI-25020WO

### Ventilador industrial de pared oscilobatiente

Ventilador de pared industrial resistente con cabezal oscilante y 3 velocidades. Ideal para fábricas, talleres y espacios amplios.

#### Especificaciones:

Voltaje 220V~260V  
Frecuencia 50-60Hz  
Potencia 120W  
Diámetro :50cm/20"  
Mando a distancia  
Cable 1.7m

EAN: 8436601647429

Regulaciones: Rohs, CE



[www.itthoninnovation.com](http://www.itthoninnovation.com)

CE Rohs



# Itthon

## Ventilación Industrial Suelo

# 01

Ref: ITTVI-25040NS

### Ventilador industrial de suelo negro

Ventilador de suelo industrial 3 velocidades.  
Ideal para fábricas, talleres y espacios amplios.

#### Especificaciones:

Voltaje 220V

Frecuencia 50Hz

Potencia 60W

Tamaño 40X40cm

Cable 1.7m

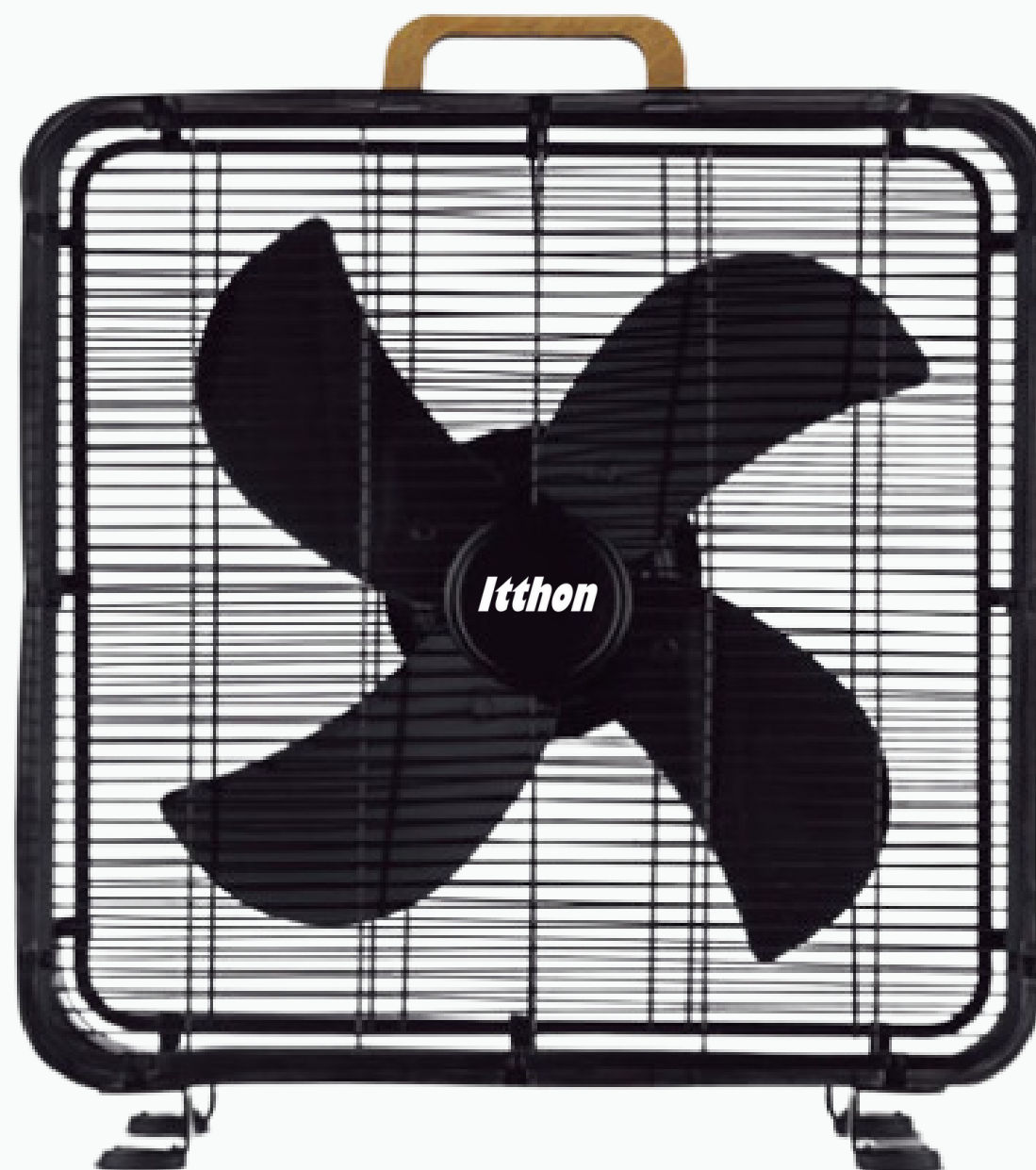

EAN: 8436601647436

Regulaciones: Rohs, CE

[www.itthoninnovation.com](http://www.itthoninnovation.com)

CE Rohs

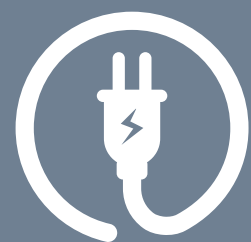

220V /50HZ



3500m<sup>3</sup>/h

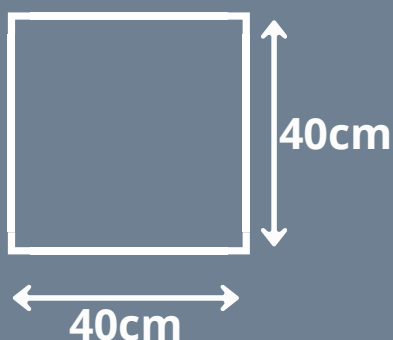

Montaje

EASY



Metálico



# Itthon

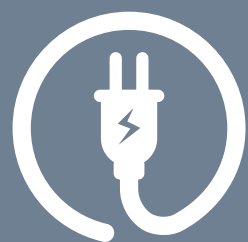

24V / 40W



175m<sup>3</sup>/h



30cm

Recargable



Metálico



# Ventilación Industrial

## Suelo

# 01

Ref: ITTVI-25012AR

### Ventilador industrial de suelo recargable

Ventilador de suelo industrial recargable resistente con cabezal oscilante y varias velocidades. Ideal para situaciones que se necesite una ventilación autónoma

#### Especificaciones:

Voltaje 24V

Potencia 40W

Motor DC

Diámetro 30cm

Batería 2400amh

Tiempo de recarga 4H



EAN:8436601647443

Regulaciones: Rohs, CE

[www.itthoninnovation.com](http://www.itthoninnovation.com)

CE Rohs



# Itthon

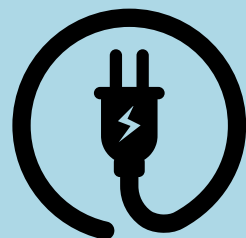

220V / 50~60HZ

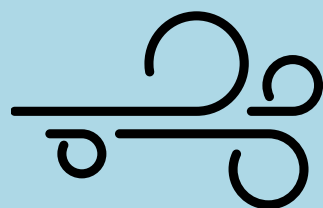

4800m<sup>3</sup>/h

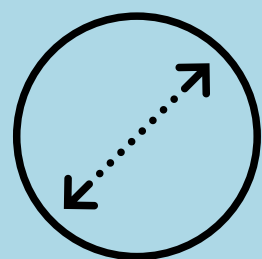

132cm

Montaje

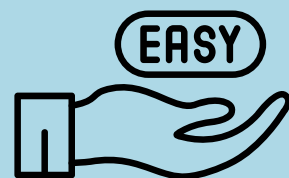

Aspas

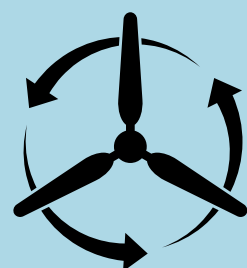

ABS

## Ventilación Techo

# 01

Ref: ITTVI-25052TL

### Ventilador industrial de techo luz led

Ventilador de techo con iluminación led 24W 3CCT  
Opciones de invierno y verano, mando a distancia  
con 6 velocidades



**Especificaciones:** Voltaje 110~220V  
Frecuencia 50~60Hz  
Potencia 35W  
Motor DC  
Velocidades 6  
Diámetro 132cm  
Mando a distancia  
Iluminación 3CCT  
Aspas ABS

EAN: 8436601647221

Regulaciones: Rohs, CE

[www.itthoninnovation.com](http://www.itthoninnovation.com)

CE Rohs





# Itthon

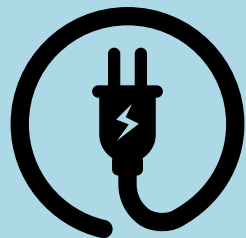

220V / 50~60HZ

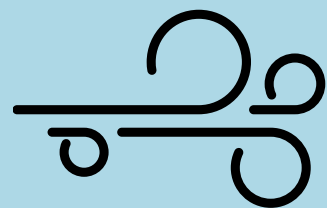

4000m<sup>3</sup>/h

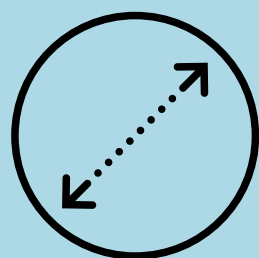

105cm

Montaje



Aspas

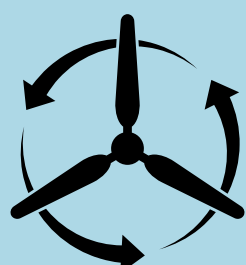

ABS

## Ventilación Techo

# 01

Ref: ITTVI-25042TL

### Ventilador industrial de techo luz led

Ventilador de techo con iluminación led 24W 3CCT  
Opciones de invierno y verano, mando a distancia  
con 6 velocidades

**Especificaciones:** Voltaje 110~220V  
Frecuencia 50~60Hz  
Potencia 35W  
Motor DC  
Velocidades 6  
Diámetro 105cm  
Mando a distancia  
Iluminación 3CCT

EAN: 8436601647214

Regulaciones: Rohs, CE



[www.itthoninnovation.com](http://www.itthoninnovation.com)

CE Rohs



# Itthon

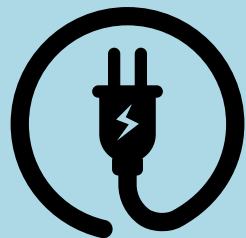

220V / 50~60HZ

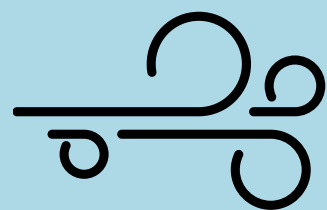

4000m<sup>3</sup>/h

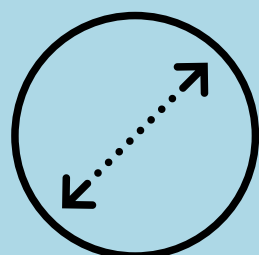

105cm

Montaje



Aspas

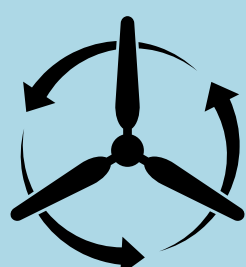

ABS

## Ventilación Techo

# 01

Ref: ITTVI-25042CT

### Ventilador industrial acero de techo luz led

Ventilador de techo con iluminación led 24W 3CCT  
Opciones de invierno y verano, mando a distancia  
con 6 velocidades

#### Especificaciones:

Voltaje 110~220V  
Frecuencia 50~60Hz  
Potencia 35W  
Motor DC  
Velocidades 6  
Diámetro 105cm  
Mando a distancia  
Iluminación 3CCT



EAN:8436601647450

Regulaciones: Rohs, CE

[www.itthoninnovation.com](http://www.itthoninnovation.com)

CE Rohs

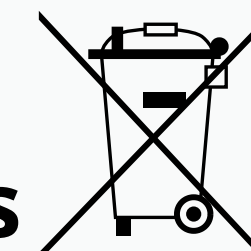

# Itthon

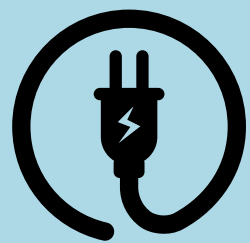

220V /50~60HZ

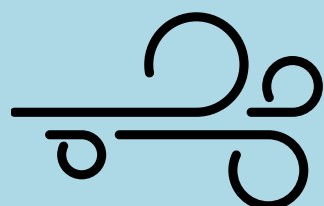

3500m<sup>3</sup>/h

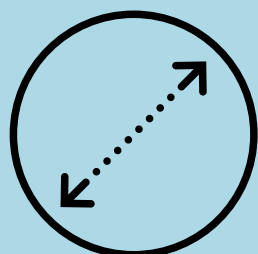

90cm

Montaje



Aspas

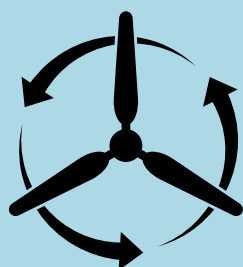

Metálica

## Ventilación Techo

Ref: AF-0223

# 01

### Ventilador industrial de techo con regulador de pared

Ventilador de techo metálico

Opciones de invierno y verano, mando a distancia con 5 velocidades



#### Especificaciones:

Voltaje 110~220V

Frecuencia 50~60Hz

Potencia 55W

Motor DC

Velocidades 5

Tamaño 90cm

#### Opciones

Tamaño 90cm/36"

Tamaño 110cm/42"

Tamaño 142cm/52"



EAN: 8436601647207

Regulaciones: Rohs, CE

[www.itthoninnovation.com](http://www.itthoninnovation.com)

CE Rohs



# Itthon

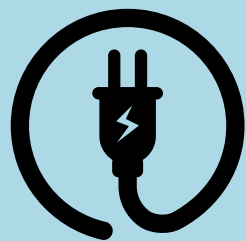

220V /50~60HZ

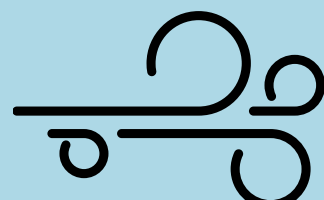

4800m<sup>3</sup>/h

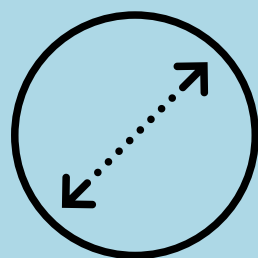

122cm

Montaje

EASY



Aspas

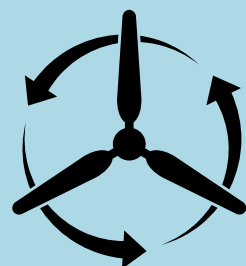

Madera

# Ventilación Techo

# 01

Ref: ITTVI-25052TM

## Ventilador industrial de techo luz led

Ventilador de techo con iluminación led 24W 3CCT  
Opciones de invierno y verano, mando a distancia  
con 6 velocidades



### Especificaciones:

Voltaje 110~220V  
Frecuencia 50~60Hz  
Potencia 72W  
Motor DC  
Velocidades 6  
Diámetro 122cm/48"  
Mando a distancia  
Iluminación 3CCT



EAN: 8436601647474

Regulaciones: Rohs, CE

[www.itthoninnovation.com](http://www.itthoninnovation.com)

CE Rohs



# Itthon

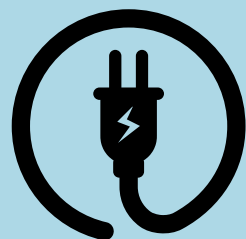

220V /50~60HZ

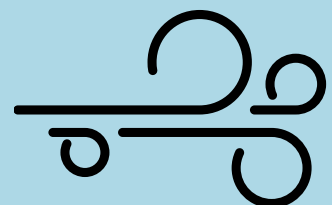

3800m<sup>3</sup>/h  
4000M<sup>3</sup>/h

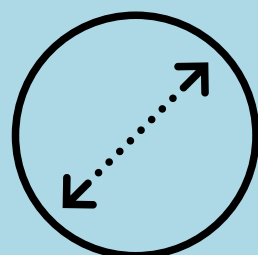

90cm  
106cm

Montaje

EASY



Aspas

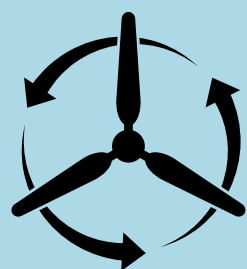

Madera

# Ventilación Techo

# 01

Ref: ITTVI-25053TM

## Ventilador industrial de techo luz led

Ventilador de techo con iluminación led 12W 3CCT  
Opciones de invierno y verano, mando a distancia  
con 6 velocidades

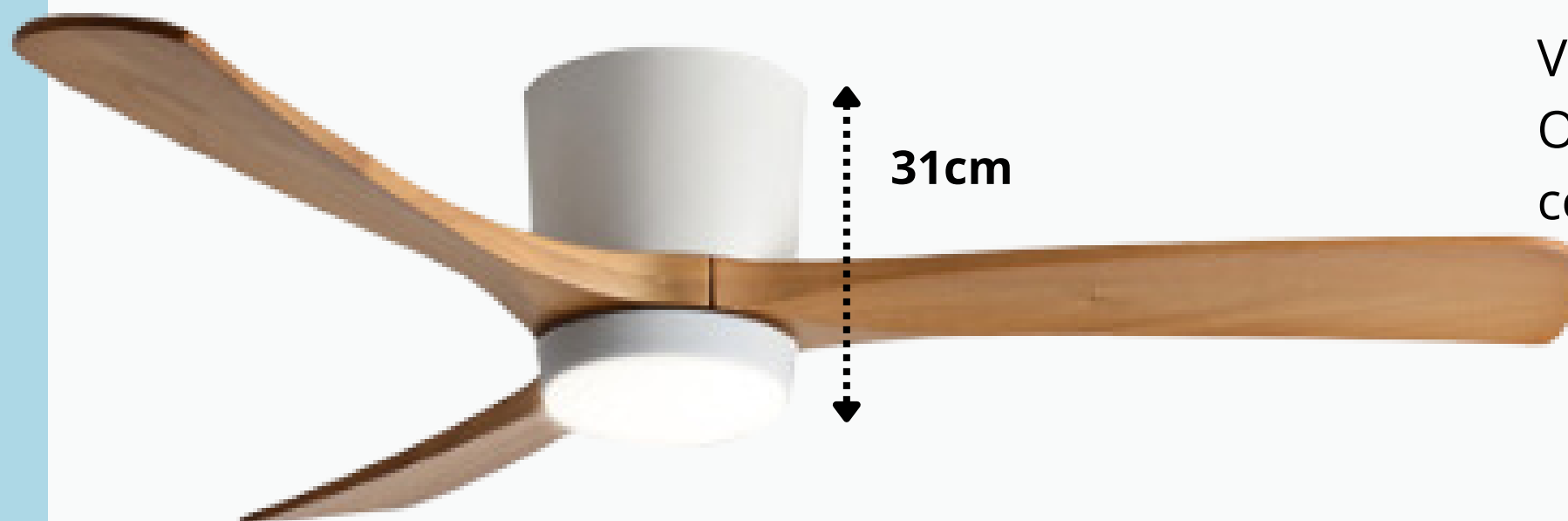

### Especificaciones:

Voltaje 110~220V  
Frecuencia 50~60Hz  
Potencia 35W  
Diámetro 90cm/36"  
Motor DC  
Velocidades 6  
Mando a distancia  
Iluminación 3CCT  
Altura 31cm

### Opciones

Diámetro 90cm/36"  
Diámetro 106cm/42"

EAN:8436601647481

Regulaciones: Rohs, CE



[www.itthoninnovation.com](http://www.itthoninnovation.com)

CE Rohs



# Itthon

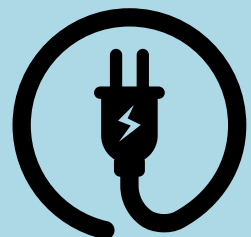

220V /50~60HZ

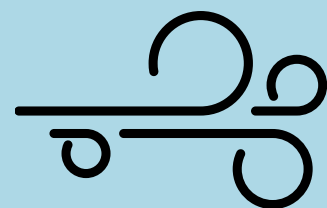

4000m<sup>3</sup>/h  
4500m<sup>3</sup>/h

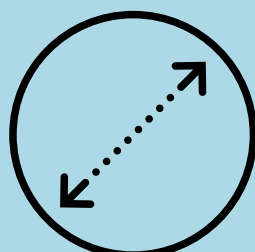

106cm  
117cm

Montaje



Aspas

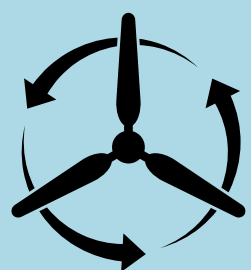

ABS

# Ventilación Techo

# 01

Ref:ITTVI-25042TP

## Ventilador industrial de techo luz led

Ventilador de techo con iluminación led 24W 3CCT  
Opciones de invierno y verano, mando a distancia  
con 6 velocidades



### Especificaciones:

Voltaje 110~220V  
Frecuencia 50~60Hz  
Potencia 35W  
Diámetro 106cm/42"  
Motor DC  
Velocidades 6  
Mando a distancia  
Iluminación 3CCT

### Opciones

Diámetro 106cm/42"  
Diámetro 117cm/46"



EAN: 8436601647498

Regulaciones: Rohs, CE

CE Rohs



[www.itthoninnovation.com](http://www.itthoninnovation.com)

# Itthon

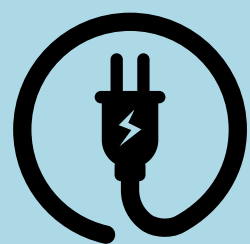

220V /50~60HZ

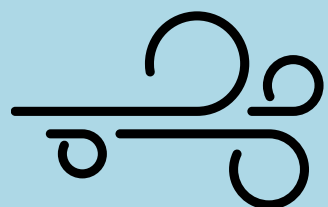

4800m<sup>3</sup>/h

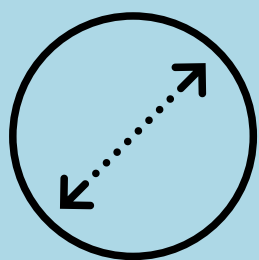

132cm

Montaje



Aspas



Madera

## Ventilación Techo

# 01

Ref: ITTVI-25052AM

### Ventilador de techo acero-madera

Ventilador de techo de acero y madera  
Opciones de invierno y verano, mando a distancia  
con 6 velocidades



#### Especificaciones:

Voltaje 110~220V  
Frecuencia 50~60Hz  
Potencia 40W  
Diámetro 132cm/52"  
Motor DC  
Velocidades 6  
Mando a distancia



EAN: 8436601647504

Regulaciones: Rohs, CE

[www.itthoninnovation.com](http://www.itthoninnovation.com)

CE Rohs



# Itthon

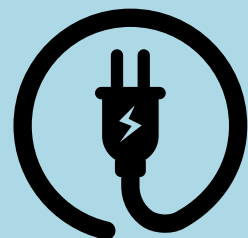

220V / 50~60HZ

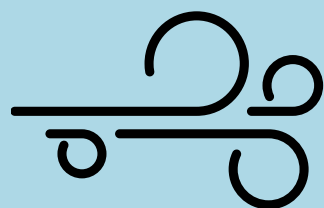

4300m<sup>3</sup>/h

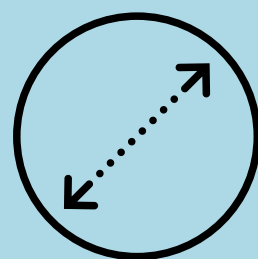

116cm

Montaje

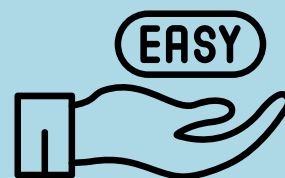

Aspas

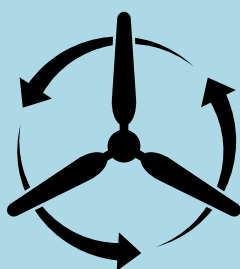

Retráctil

## Ventilación Techo

Ref: ITTVI-25048TR

01

### Ventilador de techo con aspas retráctiles luz led

Ventilador de techo con aspas retráctiles con iluminación led 80W, dos colores (opción 3CCT) Opciones de invierno y verano, mando a distancia con 6 velocidades



**Especificaciones:** Voltaje 110~220V  
Frecuencia 50~60Hz  
Potencia 35W  
Diámetro 116cm/48"  
Motor DC  
Velocidades 6  
Mando a distancia  
Iluminación 3CCT



EAN: 8436601647511

Regulaciones: Rohs, CE

[www.itthoninnovation.com](http://www.itthoninnovation.com)

CE Rohs





# Itthon

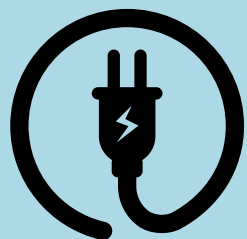

220V /50~60HZ

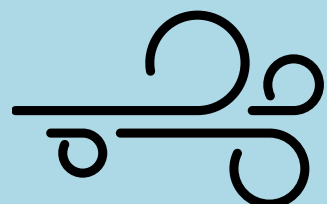

4500m<sup>3</sup>/h

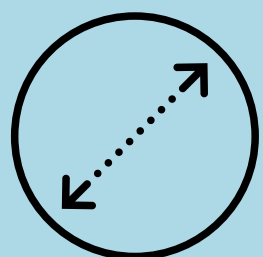

116cm

Montaje

EASY



Aspas

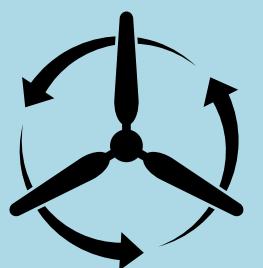

Retráctil

## Ventilación Techo

# 01

Ref: ITTVI-25048TRB

### Ventilador de techo con aspas retráctiles luz led

Ventilador de techo con aspas retráctiles con iluminación led 80W, dos colores (opción 3CCT) Opciones de invierno y verano, mando a distancia con 6 velocidades



#### Especificaciones:

Voltaje 110~220V

Frecuencia 50~60Hz

Potencia 35W

Diámetro 116cm/48"

Motor DC

Velocidades 6

Mando a distancia

Iluminación 3CCT

EAN: 8436601647528

Regulaciones: Rohs, CE



[www.itthoninnovation.com](http://www.itthoninnovation.com)

CE Rohs



# Itthon

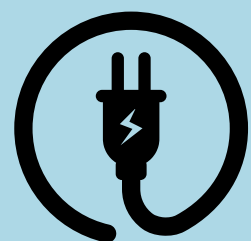

220V /50~60HZ

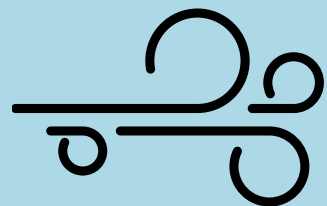

4500m<sup>3</sup>/h

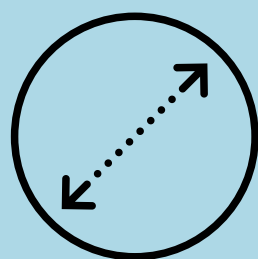

116cm

Montaje

EASY



Aspas

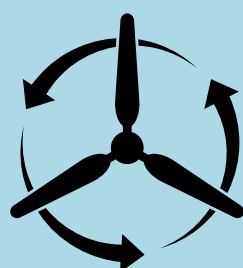

Retráctil

## Ventilación Techo

# 01

Ref: ITTVI-25048TRN

### Ventilador de techo con aspas retráctiles luz led

Ventilador de techo con aspas retráctiles con iluminación led 80W, dos colores (opción 3CCT) Opciones de invierno y verano, mando a distancia con 6 velocidades



**Especificaciones:** Voltaje 110~220V  
Frecuencia 50~60Hz  
Potencia 35W  
Diámetro 116cm/48"  
Motor DC  
Velocidades 6  
Mando a distancia  
Iluminación 3CCT

EAN: 8436601647535

Regulaciones: Rohs, CE



[www.itthoninnovation.com](http://www.itthoninnovation.com)

CE Rohs



# Itthon

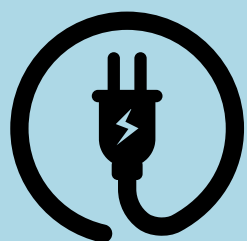

220V /50~60HZ

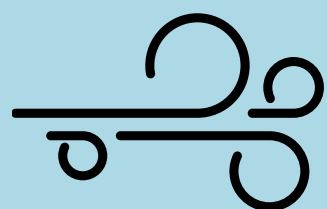

4500m<sup>3</sup>/h

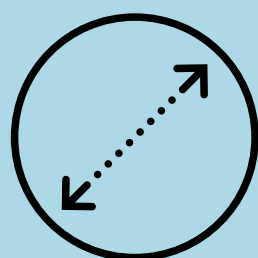

116cm

Montaje



Aspas

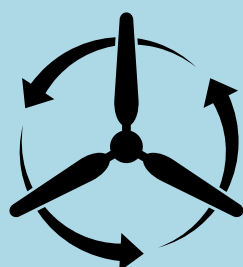

Retráctil

## Ventilación Techo

# 01

Ref: ITTVI-25048TRM

### Ventilador de techo con aspas retráctiles luz led

Ventilador de techo con aspas retráctiles, decoración en madera

Illuminación led 80W, dos colores (opción 3CCT)

Opciones de invierno y verano, mando a distancia con 6 velocidades



**Especificaciones:** Voltaje 110~220V  
Frecuencia 50~60Hz  
Potencia 35W  
Diámetro 116cm/48"  
Motor DC  
Velocidades 6  
Mando a distancia  
Iluminación 3CCT



EAN: 8436601647542

Regulaciones: Rohs, CE

[www.itthoninnovation.com](http://www.itthoninnovation.com)

CE Rohs



# Itthon

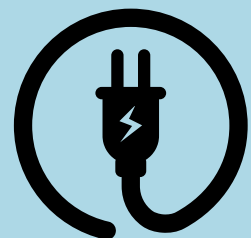

110v-220V  
50~60HZ

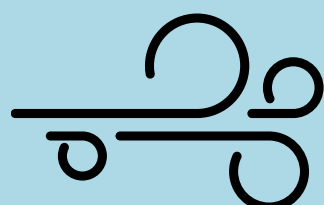

4000 m<sup>3</sup>/h

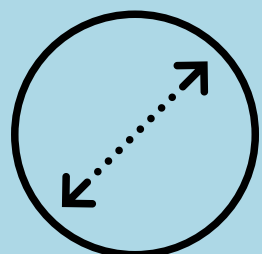

106cm  
Montaje

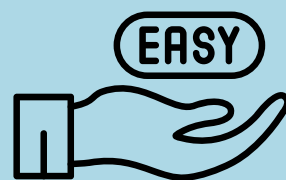

Aspas

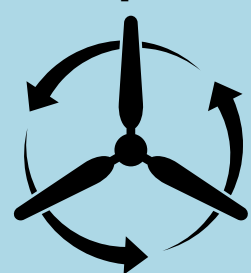

Retráctil

## Ventilación Techo

Ref: ITTVI-25042TR

01

### Ventilador de techo con aspas retráctiles luz led

Ventilador de techo con aspas retráctiles con iluminación led 24W, 3CCT  
Opciones de invierno y verano, mando a distancia con 6 velocidades

#### Especificaciones:

Voltaje 110~220V  
Frecuencia 50~60Hz  
Potencia 36W  
Diámetro 106cm/42"  
Motor DC  
Velocidades 6  
Mando a distancia  
Iluminación 3CCT  
Altura 28cm

EAN: 8436601647559

Regulaciones: Rohs, CE



[www.itthoninnovation.com](http://www.itthoninnovation.com)

CE Rohs



# Itthon

## Ventilación Techo

# 01

Ref: ITTVI-25018TRN

### Ventilador industrial de techo luz led -Negro

Ventilador de techo con iluminación led 40W 3CCT  
Opciones de invierno y verano, mando a distancia  
con 6 velocidades

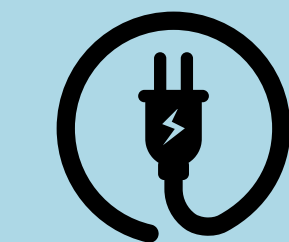

220V /50~60HZ

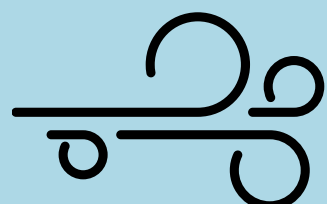

2500m<sup>3</sup>/h

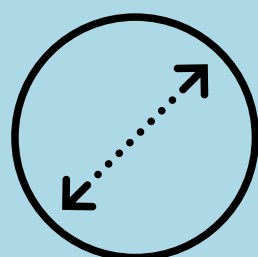

47cm

Montaje



Aspas



ABS

#### Especificaciones:

Voltaje 110~220V  
Frecuencia 50~60Hz  
Potencia 20W  
Diámetro 47cm/18"  
Motor DC  
Mando a distancia  
Iluminación 3CCT  
Altura 14cm

EAN: 8436601647566

Regulaciones: Rohs, CE

[www.itthoninnovation.com](http://www.itthoninnovation.com)

CE Rohs



# Itthon

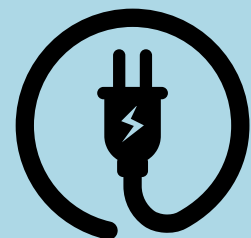

220V / 50~60HZ

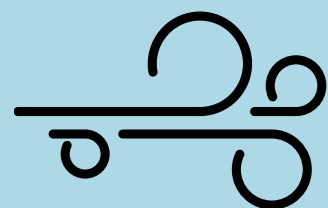

2500m<sup>3</sup>/h

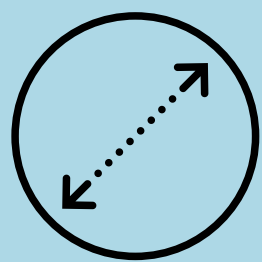

47cm

Montaje

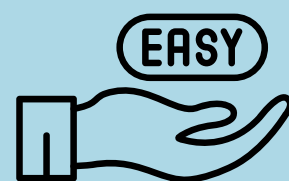

Aspas

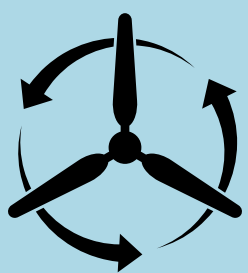

ABS

## Ventilación Techo

# 01

Ref: ITTVI-25018TRB

### Ventilador industrial de techo luz led -Plata

Ventilador de techo con iluminación led 40W 3CCT  
Opciones de invierno y verano, mando a distancia  
con 6 velocidades



**Especificaciones:** Voltaje 110~220V  
Frecuencia 50~60Hz  
Potencia 20W  
Diámetro 47cm/18"  
Motor DC  
Mando a distancia  
Iluminación 3CCT  
Altura 14cm

EAN: 8436601647573

Regulaciones: Rohs, CE

CE Rohs



[www.itthoninnovation.com](http://www.itthoninnovation.com)

# Itthon

## Ventilación Techo

# 01

Ref: ITTVI-25100TL

### Ventilador industrial Gran Tamaño 200cm

Ventilador de techo gran formato ,acero y negro  
Opciones de invierno y verano,mando a distancia  
con 6 velocidades



**Especificaciones:** Voltaje 110~220V  
Frecuencia 50~60Hz  
Potencia 55W  
Diámetro 200cm/78"  
Motor DC  
Velocidades 6  
Mando a distancia

**EAN:** 8436601647238

**Regulaciones:** Rohs, CE

**CE Rohs**



[www.itthoninnovation.com](http://www.itthoninnovation.com)

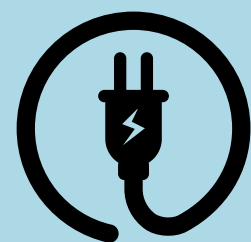

220V /50~60HZ

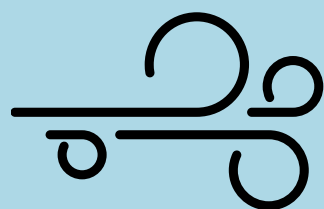

6000m<sup>3</sup>/h

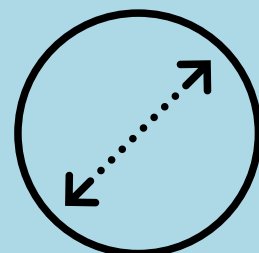

200cm

Montaje



Aspas

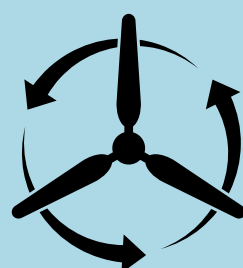

Madera

# Itthon

## Ventilación Techo

# 01

Ref: ITTVI-25101TL

**Ventilador industrial Gran Tamaño 200cm**

Ventilador de techo gran formato ,blanco  
Opciones de invierno y verano,mando a distancia  
con 6 velocidades

**Especificaciones:**

Voltaje 110~220V  
Frecuencia 50~60Hz  
Potencia 55W  
Diámetro 200cm/78"  
Motor DC  
Velocidades 6  
Mando a distancia

**EAN: 8436601647580**

**Regulaciones:** Rohs, CE

**CE Rohs**

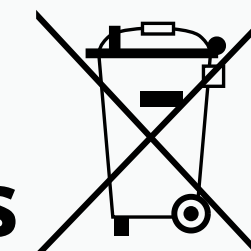

[www.itthoninnovation.com](http://www.itthoninnovation.com)

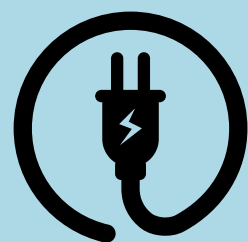

220V /50~60HZ

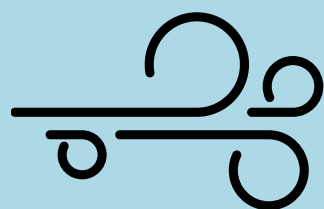

6000m<sup>3</sup>/h

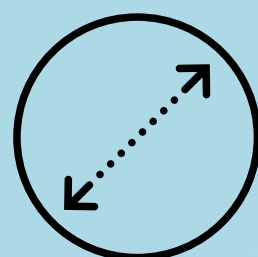

200cm

Montaje

EASY



Aspas

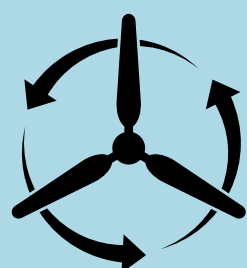

Madera







## NEBULIZADORES

Ref: N30B

### Ventilador nebulizador

Ventilador nebulizador doméstico recomendado para estancias de unos 10-12m<sup>2</sup>  
Nebulización regulable

**Especificaciones:** Voltaje 110~220V  
Frecuencia 50~60Hz  
Potencia 75W  
Diámetro 40cm  
Motor DC  
Oscilobatiente  
Tanque 2.5l  
Mando a distancia

**EAN: 8436601648235**

**Regulaciones:** Rohs, CE



## NEBULIZADORES

Ref: ITTVI-25026NN

### Ventilador nebulizador industrial

Ventilador nebulizador industrial recomendado para estancias de unos 30-50m<sup>2</sup>

Nebulización regulable

**Especificaciones:** Voltaje 110~220V  
Frecuencia 50~60Hz  
Potencia 55W  
Diámetro 65cm  
Motor DC  
Oscilobatiente  
Tanque 40l  
Mando a distancia

**EAN: 8436601648341**

**Regulaciones:** Rohs, CE

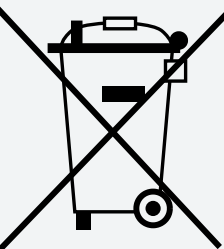

# Itthon

www.itthoninnovation.com



## NEBULIZADORES

Ref:ITTVI-25080NN

### Ventilador nebulizador industrial

Ventilador nebulizador industrial recomendado para estancias de unos 50-80m<sup>2</sup>  
Nebulización regulable

**Especificaciones:** Voltaje 110~220V  
Frecuencia 50HZ  
Potencia 170W  
Diámetro 68cm  
Motor DC  
Oscilobatiente  
Tanque 30l

**EAN: 8436601647597**

**Regulaciones:** Rohs, CE



# Itthon

www.itthoninnovation.com



# EVAPORATIVOS

Ref: ITTVE-25030V

## Ventilador evaporativo industrial

Ventilador evaporativo industrial recomendado para estancias de unos 25-40m<sup>2</sup>

Flujo de aire regulable

Tamaño 50x35x89cm

### Especificaciones:

Voltaje 110~220V

Frecuencia 50~60Hz

Potencia 120W

Motor DC

Tanque 30l

Mando a distancia

Caudal 6000m<sup>3</sup>/h

EAN:8436601647603

Regulaciones: Rohs, CE

CE Rohs

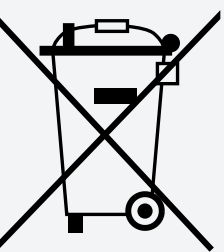

# Itthon

www.itthoninnovation.com

04



## EVAPORATIVOS

Ref: ITTVE-25050M

### Ventilador evaporativo industrial

Ventilador evaporativo industrial recomendado para estancias de unos 35-50m<sup>2</sup>

Flujo de aire regulable

Tamaño 59x41x119cm

#### Especificaciones:

Voltaje 110~220V

Frecuencia 50~60Hz

Potencia 150W

Motor DC

Tanque 50l

Mando a distancia

Caudal 8000m<sup>3</sup>/h

EAN:8436601647610

Regulaciones: Rohs, CE

CE Rohs

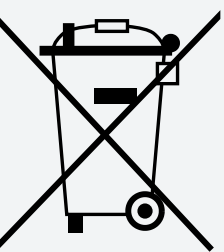

# Itthon

www.itthoninnovation.com

04



## EVAPORATIVOS

Ref: ITTVE-25070V

### Ventilador evaporativo industrial

Ventilador evaporativo industrial recomendado para estancias de unos 50-100m<sup>2</sup>

Flujo de aire regulable

Tamaño 65x44x128cm

### Especificaciones:

Voltaje 110~220V

Frecuencia 50~60Hz

Potencia 280W

Motor DC

Tanque 70l

Mando a distancia

Caudal 12000m<sup>3</sup>/h

EAN: 8436601647627

Regulaciones: Rohs, CE

CE

Rohs

